

# Fluid Cooling Shell & Tube HC Series

## COPPER & STEEL CONSTRUCTION

### Performance Notes

- Preferred for new oil-water applications
- Rugged steel construction
- Low cost
- NPT, SAE O-Ring, SAE flange, or BSPP shell side connections available
- End bonnets removable for servicing
- Mounting feet included (may be rotated in 90° increments)

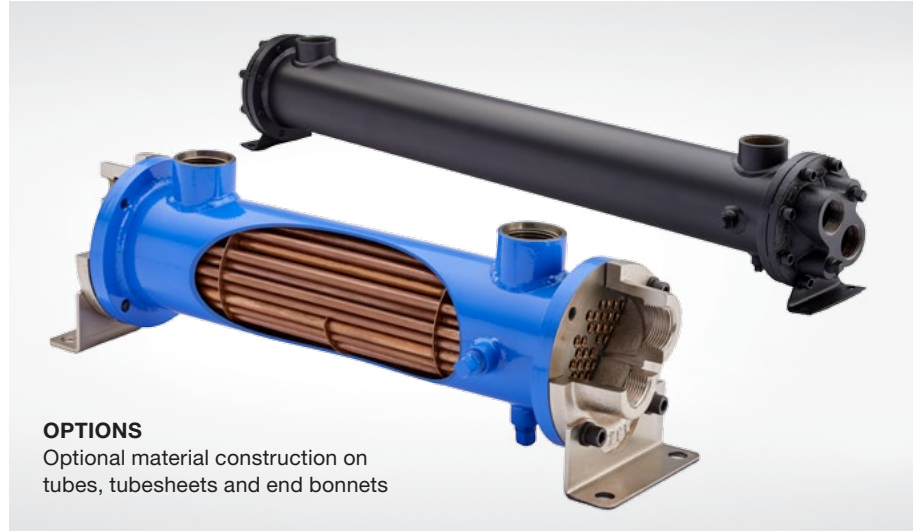

#### OPTIONS

Optional material construction on tubes, tubesheets and end bonnets

## Ratings

**Maximum Operating Pressure - Shell Side**  
300 PSI\*

**Maximum Operating Pressure - Tube Side**  
150 PSI

**Maximum Operating Temperature**  
300°F

## Materials

**Tubes** Copper

**Tubesheet** Carbon steel

**Shell** Carbon steel

**Baffles** Carbon steel

**End Bonnets** Cast iron

**Mounting Brackets** Carbon steel

**Gaskets** Nitrile rubber/cellulose fiber

**Nameplate** Aluminum foil

## How to Order

	-		-		-		-		-		-					
<b>Model Series</b>		<b>Model Size Selected</b>		<b>Baffle Spacing</b> (See page xx for options)		<b>Tube Diameter Code</b> 4 - 1/4" (standard for 600 & 800 Series) 6 - 3/8" (standard for 1000, 1200 & 1700 Series)		<b>Tubeside Passes</b> 0 - One Pass T - Two Pass F - Four Pass		<b>Cooling Tube Material</b> Blank - Copper CN - CuNi SS - Stainless Steel AD - Admiralty Brass		<b>End Bonnet Material</b> Blank - Cast Iron B - Bronze SB - Stainless Steel		<b>Tubesheet Material</b> Blank - Carbon Steel W - CuNi S - Stainless Steel		<b>Zinc Anodes</b> Blank - None Z - Zinc

HC = NPT Shell Side Connectors; NPT Tube Side Connections

HCS = SAE ORB Shell Side Connectors; NPT Tube Side Connections

HCF = SAE Code 61 Flanges on Shell Side (UNC Threads); NPT Tube Side Connections

HCM = BSPP Shell Side Connectors; BSPP Tube Side Connections

\*HCA = 150# ASME RF Flanges on Shell Side; NPT Tube Side Connections. Shell Maximum Pressure Rating is 150 psi

HCFM = SAE Code 61 Flanges on Shell Side (Metric Threads); NPT Tube Side Connections

# Dimensions

## One Pass

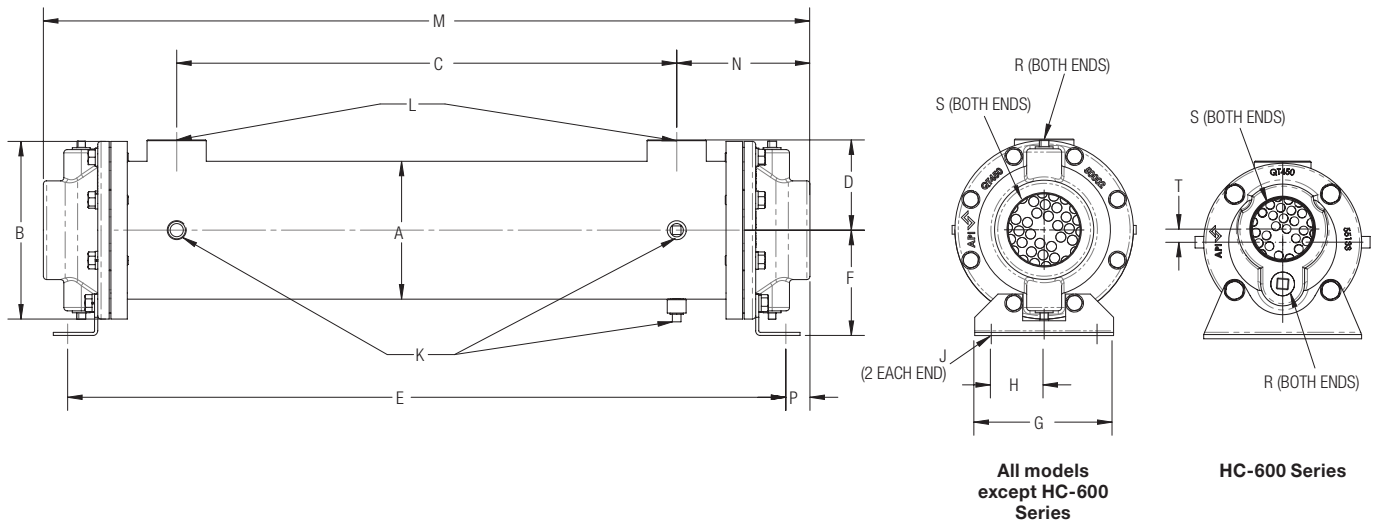

Model	A	B	C	D	E	F	G	H	J	K NPT	L NPT	M	N	P	R NPT	S NPT	T
614	3.27	4.50	10.00	2.31	16.37	2.75	4.50	1.63	0.44	0.25	1.00	17.31	3.66	0.47	.38 (2)	1.50	0.38
624	3.27	4.50	20.00	2.31	26.37	2.75	4.50	1.63	0.44	0.25	1.00	27.31	3.66	0.47	.38 (2)	1.50	0.38
814	4.25	6.00	9.00	3.13	16.50	3.50	4.25	1.75	0.44	0.25	1.50	17.88	4.44	0.69	.38 (2)	2.00	—
824	4.25	6.00	19.00	3.13	26.50	3.50	4.25	1.75	0.44	0.25	1.50	27.88	4.44	0.69	.38 (2)	2.00	—
836	4.25	6.00	31.00	3.13	38.50	3.50	4.25	1.75	0.44	0.25	1.50	39.88	4.44	0.69	.38 (2)	2.00	—
1014	5.24	6.75	9.00	3.43	17.29	4.00	5.25	2.00	.50 x .75	0.25	1.50	19.13	5.06	0.92	.38 (4)	2.00	—
1024	5.24	6.75	19.00	3.43	27.29	4.00	5.25	2.00	.50 x .75	0.25	1.50	29.13	5.06	0.92	.38 (4)	2.00	—
1036	5.24	6.75	31.00	3.43	39.29	4.00	5.25	2.00	.50 x .75	0.25	1.50	41.13	5.06	0.92	.38 (4)	2.00	—
1224	6.26	7.75	18.25	4.06	27.00	4.50	6.25	2.50	.50 x .75	0.38	2.00	29.63	5.69	1.31	.50 (4)	3.00	—
1236	6.26	7.75	30.25	4.06	39.00	4.50	6.25	2.50	.50 x .75	0.38	2.00	41.63	5.69	1.31	.50 (4)	3.00	—
1248	6.26	7.75	42.25	4.06	51.00	4.50	6.25	2.50	.50 x .75	0.38	2.00	53.63	5.69	1.31	.50 (4)	3.00	—
1260	6.26	7.75	55.25	4.06	63.00	4.50	6.25	2.50	.50 x .75	0.38	2.00	65.63	5.69	1.31	.50 (4)	3.00	—
1724	8.62	10.50	17.00	5.43	27.25	5.75	7.25	3.50	.63 x .88	0.38	3.00	31.75	7.38	2.25	.50 (4)	4.00	—
1736	8.62	10.50	29.00	5.43	39.25	5.75	7.25	3.50	.63 x .88	0.38	3.00	43.75	7.38	2.25	.50 (4)	4.00	—
1748	8.62	10.50	41.00	5.43	51.25	5.75	7.25	3.50	.63 x .88	0.38	3.00	55.75	7.38	2.25	.50 (4)	4.00	—
1760	8.62	10.50	53.00	5.43	63.25	5.75	7.25	3.50	.63 x .88	0.38	3.00	67.75	7.38	2.25	.50 (4)	4.00	—
1772	8.62	10.50	65.00	5.43	75.25	5.75	7.25	3.50	.63 x .88	0.38	3.00	79.75	7.38	2.25	.50 (4)	4.00	—

# Dimensions

## Two Pass

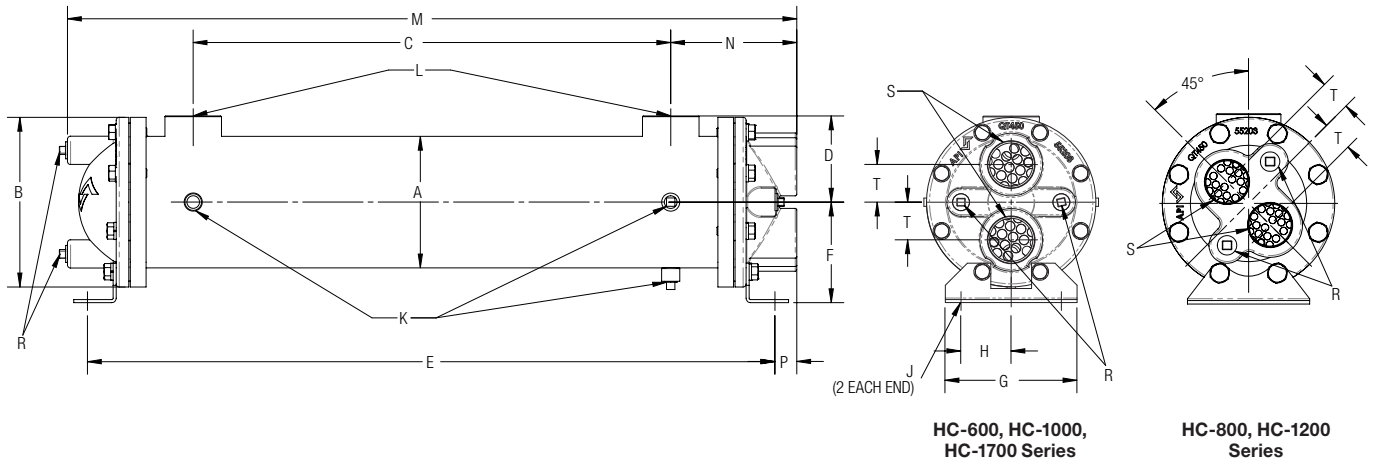

Model	A	B	C	D	E	F	G	H	J	K NPT	L NPT	M	N	P	R NPT	S NPT	T
614	3.27	4.50	10.00	2.31	16.37	2.75	4.50	1.63	0.44	0.25	1.00	17.19	3.62	0.44	.38 (2)	0.75	1.00
624	3.27	4.50	20.00	2.31	26.37	2.75	4.50	1.63	0.44	0.25	1.00	27.19	3.62	0.44	.38 (2)	0.75	1.00
814	4.25	6.00	9.00	3.13	16.56	3.50	4.25	1.75	0.44	0.25	1.50	17.87	4.44	0.69	.38 (3)	0.75	1.25
824	4.25	6.00	19.00	3.13	26.56	3.50	4.25	1.75	0.44	0.25	1.50	27.87	4.44	0.69	.38 (3)	0.75	1.25
836	4.25	6.00	31.00	3.13	38.56	3.50	4.25	1.75	0.44	0.25	1.50	39.87	4.44	0.69	.38 (3)	0.75	1.25
1014	5.24	6.75	9.00	3.43	17.35	4.00	5.25	2.00	.50 x .75	0.25	1.50	18.83	4.83	0.69	.38 (3)	1.00	1.69
1024	5.24	6.75	19.00	3.43	27.35	4.00	5.25	2.00	.50 x .75	0.25	1.50	28.83	4.83	0.69	.38 (3)	1.00	1.69
1036	5.24	6.75	31.00	3.43	39.35	4.00	5.25	2.00	.50 x .75	0.25	1.50	40.83	4.83	0.69	.38 (3)	1.00	1.69
1224	6.26	7.75	18.25	4.06	27.07	4.50	6.25	2.50	.50 x .75	0.38	2.00	28.94	5.25	0.87	.38 (3)	1.50	2.00
1236	6.26	7.75	30.25	4.06	39.07	4.50	6.25	2.50	.50 x .75	0.38	2.00	40.94	5.25	0.87	.38 (3)	1.50	2.00
1248	6.26	7.75	42.25	4.06	51.07	4.50	6.25	2.50	.50 x .75	0.38	2.00	52.94	5.25	0.87	.38 (3)	1.50	2.00
1260	6.26	7.75	55.25	4.06	64.07	4.50	6.25	2.50	.50 x .75	0.38	2.00	65.94	5.25	0.87	.38 (3)	1.50	2.00
1724	8.62	10.50	17.00	5.43	27.31	5.75	7.25	3.50	.63 x .88	0.38	3.00	30.70	7.20	2.08	.38 (3)	2.00	2.50
1736	8.62	10.50	29.00	5.43	39.31	5.75	7.25	3.50	.63 x .88	0.38	3.00	42.70	7.20	2.08	.38 (3)	2.00	2.50
1748	8.62	10.50	41.00	5.43	51.31	5.75	7.25	3.50	.63 x .88	0.38	3.00	54.70	7.20	2.08	.38 (3)	2.00	2.50
1760	8.62	10.50	53.00	5.43	63.31	5.75	7.25	3.50	.63 x .88	0.38	3.00	66.70	7.20	2.08	.38 (3)	2.00	2.50
1772	8.62	10.50	65.00	5.43	75.31	5.75	7.25	3.50	.63 x .88	0.38	3.00	78.70	7.20	2.08	.38 (3)	2.00	2.50

# Dimensions

## Four Pass

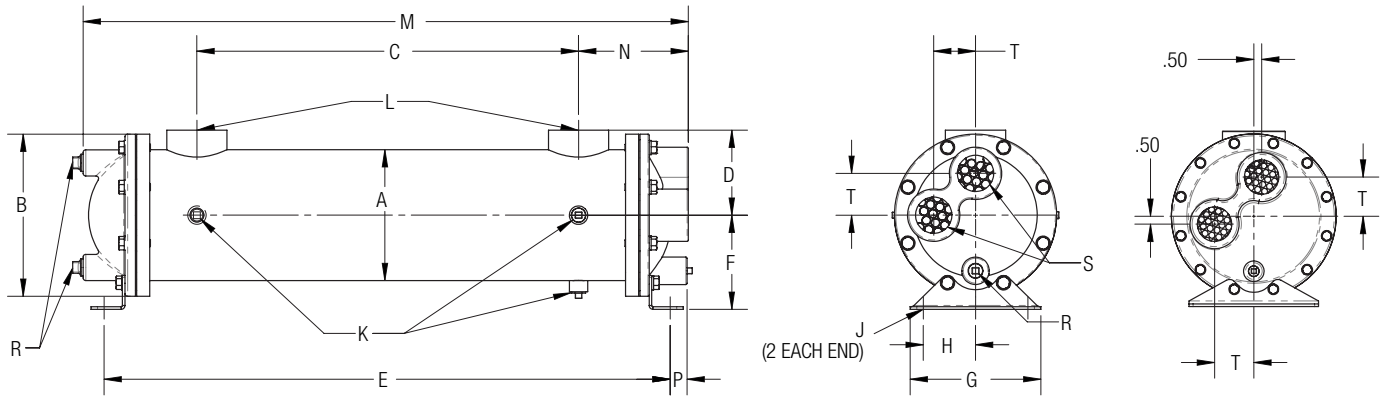

All models except  
HC-1700 Series

HC-1700 Series

Model	A	B	C	D	E	F	G	H	J	K NPT	L NPT	M	N	P	R NPT	S NPT	T
614	3.27	4.50	10.00	2.31	16.37	2.75	4.50	1.63	0.44	0.25	1.00	17.20	3.64	0.45	.38 (4)	1.00	1.00
624	3.27	4.50	20.00	2.31	26.37	2.75	4.50	1.63	0.44	0.25	1.00	27.20	3.64	0.45	.38 (4)	1.00	1.00
814	4.25	6.00	9.00	3.13	16.56	3.50	4.25	1.75	0.44	0.25	1.50	17.88	4.44	0.69	.38 (4)	1.25	1.06
824	4.25	6.00	19.00	3.13	26.56	3.50	4.25	1.75	0.44	0.25	1.50	27.88	4.44	0.69	.38 (4)	1.25	1.06
836	4.25	6.00	31.00	3.13	38.56	3.50	4.25	1.75	0.44	0.25	1.50	39.88	4.44	0.69	.38 (4)	1.25	1.06
1014	5.24	6.75	9.00	3.43	17.35	4.00	5.25	2.00	.50 x .75	0.25	1.50	19.02	5.02	0.87	.38 (4)	1.50	1.50
1024	5.24	6.75	19.00	3.43	27.35	4.00	5.25	2.00	.50 x .75	0.25	1.50	29.02	5.02	0.87	.38 (4)	1.50	1.50
1036	5.24	6.75	31.00	3.43	39.35	4.00	5.25	2.00	.50 x .75	0.25	1.50	41.02	5.02	0.87	.38 (4)	1.50	1.50
1224	6.26	7.75	18.25	4.06	27.06	4.50	6.25	2.50	.50 x .75	0.38	2.00	28.94	5.25	0.88	.38 (2 - 1/0) .50 (2 - RET)	2.00	1.56
1236	6.26	7.75	30.25	4.06	39.06	4.50	6.25	2.50	.50 x .75	0.38	2.00	40.94	5.25	0.88		2.00	1.56
1248	6.26	7.75	42.25	4.06	51.06	4.50	6.25	2.50	.50 x .75	0.38	2.00	52.94	5.25	0.88		2.00	1.56
1260	6.26	7.75	55.25	4.06	63.06	4.50	6.25	2.50	.50 x .75	0.38	2.00	64.94	5.25	0.88		2.00	1.56
1724	8.62	10.50	17.00	5.43	27.31	5.75	7.25	3.50	.63 x .88	0.38	3.00	30.07	7.20	2.08	.50 (4)	2.50	2.25
1736	8.62	10.50	29.00	5.43	39.31	5.75	7.25	3.50	.63 x .88	0.38	3.00	42.07	7.20	2.08	.50 (4)	2.50	2.25
1748	8.62	10.50	41.00	5.43	51.31	5.75	7.25	3.50	.63 x .88	0.38	3.00	54.07	7.20	2.08	.50 (4)	2.50	2.25
1760	8.62	10.50	53.00	5.43	63.31	5.75	7.25	3.50	.63 x .88	0.38	3.00	66.07	7.20	2.08	.50 (4)	2.50	2.25
1772	8.62	10.50	65.00	5.43	75.31	5.75	7.25	3.50	.63 x .88	0.38	3.00	78.07	7.20	2.08	.50 (4)	2.50	2.25

# Performance Curves

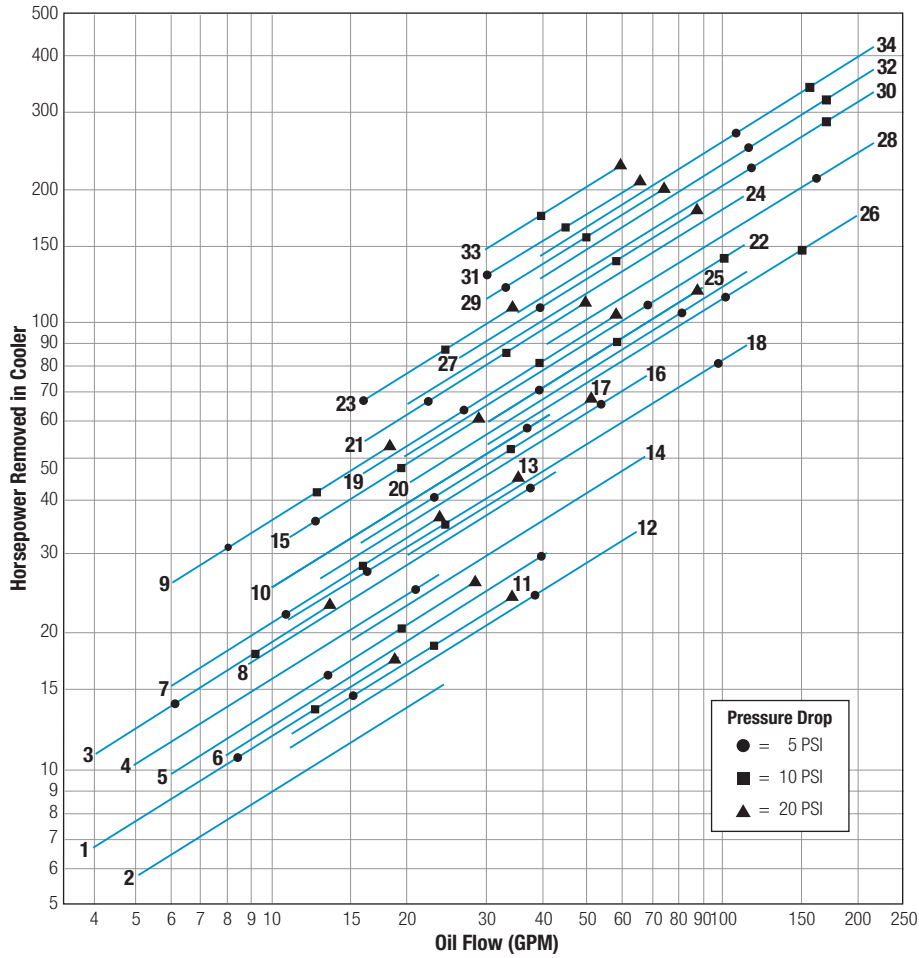

Curve Number	Model	Shipping Weight (LBS)
1	HC-614-1.3-4-F	17
2	HC-614-3-4-F	17
3	HC-624-1.3-4-F	24
4	HC-624-3-4-F	24
5	HC-814-1.7-4-F	32
6	HC-814-4-4-F	32
7	HC-824-1.7-4-F	41
8	HC-824-4-4-F	41
9	HC-836-1.7-4-F	53
10	HC-836-4-4-F	53
11	HC-1014-2-6-F	43
12	HC-1014-5-6-F	43
13	HC-1024-2-6-F	57
14	HC-1024-5-6-F	57
15	HC-1036-2-6-F	72
16	HC-1036-5-6-F	72
17	HC-1224-2.5-6-F	85
18	HC-1224-6-6-F	85
19	HC-1236-2.5-6-F	110
20	HC-1236-6-6-F	110
21	HC-1248-2.5-6-F	135
22	HC-1248-6-6-F	135
23	HC-1260-2.5-6-F	160
24	HC-1260-6-6-F	160
25	HC-1724-3.5-6-F	140
26	HC-1724-8.4-6-F	140
27	HC-1736-3.5-6-F	180
28	HC-1736-8.4-6-F	180
29	HC-1748-3.5-6-F	220
30	HC-1748-8.4-6-F	220
31	HC-1760-3.5-6-F	260
32	HC-1760-8.4-6-F	260
33	HC-1772-3.5-6-F	300
34	HC-1772-8.4-6-F	300

Shipping weights are approximate.

# Selection Procedure

Performance Curves are based on 100SSU oil leaving the cooler 40°F higher than the incoming water temperature (40°F approach temperature). Curves are based on a 2:1 oil to water ratio.

**STEP 1 Determine the Heat Load.** This will vary with different systems, but typically coolers are sized to remove 25 to 50% of the input nameplate horsepower. (Example: 100 HP Power Unit x .33 = 33 HP Heat load.)  
If BTU/HR is known:  $HP = \frac{BTU/HR}{2545}$

**STEP 2 Determine Approach Temperature.**  
Desired oil leaving cooler °F – Water Inlet temp. °F = Actual Approach

**STEP 3 Determine Curve Horsepower Heat Load.** Enter the information from above:  
 $HP \text{ heat load} \times \frac{40}{\text{Actual Approach}} \times \frac{\text{Viscosity}}{\text{Correction A}} = \text{Curve Horsepower}$

**STEP 4 Enter curves** at oil flow through cooler and curve horsepower. Any curve above the intersecting point will work.

**STEP 5 Determine Oil Pressure Drop from Curves.** Multiply pressure drop from curve by correction factor B found on oil viscosity correction curve.  
● = 5 PSI   ■ = 10 PSI   ▲ = 20 PSI

## Oil Temperature

Oil coolers can be selected by using entering or leaving oil temperatures.

Typical operating temperature ranges are:

Hydraulic Motor Oil	110°F - 130°F
Hydrostatic Drive Oil	130°F - 180°F
Lube Oil Circuits	110°F - 130°F
Automatic Transmission Fluid	200°F - 300°F

## Desired Reservoir Temperature

**Return Line Cooling:** Desired temperature is the oil temperature leaving the cooler. This will be the same temperature that will be found in the reservoir.

**Off-Line Recirculation Cooling Loop:** Desired temperature is the temperature entering the cooler. In this case, the oil temperature change must be determined so that the actual oil leaving temperature can be found. Calculate the oil temperature change (Oil ΔT) with this formula:

$$\text{Oil } \Delta T = (\text{BTUs/HR}) / (\text{GPM Oil Flow} \times 210)$$

To calculate the oil leaving temperature from the cooler, use this formula:

$$\text{Oil Leaving Temperature} = \text{Oil Entering Temperature} - \text{Oil } \Delta T$$

This formula may also be used in any application where the only temperature available is the entering oil temperature.

**Oil Pressure Drop:** Most systems can tolerate a pressure drop through the heat exchanger of 20 to 30 PSI. Excessive pressure drop should be avoided. Care should be taken to limit pressure drop to 5 PSI or less for case drain applications where high back pressure may damage the pump shaft seals.

## Viscosity Correction

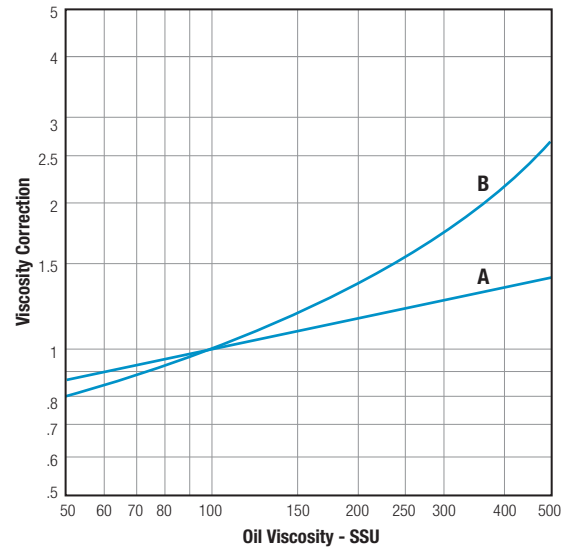

## Maximum Flow Rates

Example Model No.  
**HC - 1024 - 2 - 6 - F**

Unit Size	Baffle Spacing	Shell Side (GPM)	Tube Side (GPM)		
			O	T	F
600	1.3, 3	19, 29	48	24	12
800	1.7, 4	32, 69	84	42	21
1000	2, 5	41, 69	146	73	37
1200	2.5, 6	60, 115	224	112	56
1700	3.5, 8.4	125, 253	465	232	116

Exceptions to Maximum Shell Side Flows	
HC-814-4-4-*	63 GPM Max.
HC-1014-2-6-*	33 GPM Max.
HC-1014-5-6-*	66 GPM Max.
HC-1724-3.5-6-*	105 GPM Max.
HC-1724-8.4-6-*	200 GPM Max.

**Caution:** Incorrect installation can cause this product to fail prematurely, causing the shell side and tube side fluids to intermix.

## Piping Diagram

### One Pass

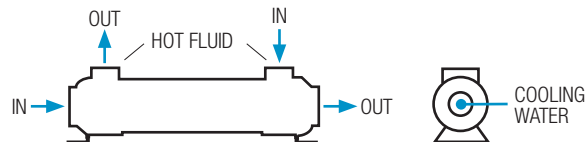

### Two and Four Pass

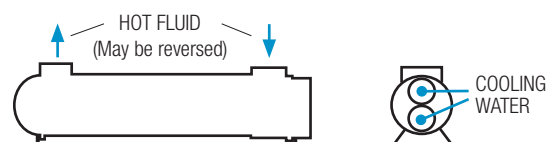

Specific applications may have different piping arrangements. Contact factory for assistance.