

# DH Series – Mobile Air Cooled Copper Tube/Aluminum-Steel Fin Cores

The DH Series is a low cost, high performance mobile core that is an excellent choice for radiator face mount fuel or transmission cooling. This series features moderate flows, high heat removal and an optional internal pressure bypass for cold start-up protection. Material options are also available including steel tanks and steel fins for rugged off-highway applications. Aggressive turbulators allow for optimal heat rejection at lower flow rates.

For additional sizing information consider using TTP's XSelector® online sizing Program.\*

- Hayden interchange
- Heavy duty construction
- Rugged steel manifolds (DH-513 thru DH-670)
- Copper manifolds (DH-051 thru DH-447)
- 3/4" tube size
- Aluminum or Steel fins
- SAE or NPT connections
- Eliminate piping, reduce cost with optional internal pressure bypass

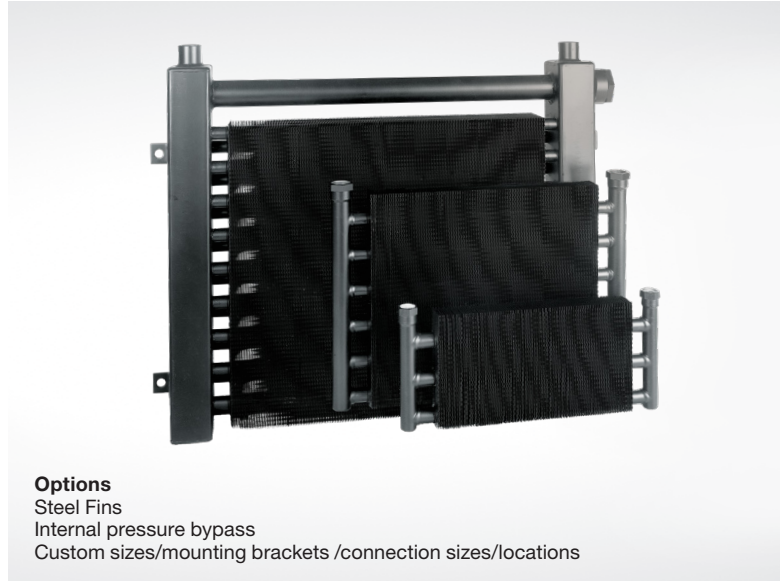

## How to Order

### Model Series

**DH**  
**DHR** - Internal pressure bypass included

### Model Size Selected

051, 062, 073, 084, 095, 106, 117, 194, 205, 216  
227, 249, 326, 337, 348, 359, 370, 425, 447.  
513, 524, 535, 626, 670

### Connection Type

1 - NPT  
2 - SAE

### Fin Material

1 - Aluminum  
2 - Steel

### Bypass Setting (DHR only)

**Blank** - No Bypass  
**30** - 30 PSI Pressure Bypass  
**60** - 60 PSI Pressure Bypass

This is a partial flow pressure bypass only. It is not designed to be a full flow system bypass.

## Ratings

**Maximum Operating Pressure**  
300 PSI

**Test Pressure**  
300 PSI

**Maximum Operating Temperature**  
350°F

**Heat Removal to 70 HP (92 kW)**  
**Oil Flows to 150 GPM (330 lpm)**

## Materials

**Tubes** Copper

**Fins** Aluminum / Steel (optional)

**Turbulators** Aluminum

**Manifolds** Copper (DH-051 – DH-447)  
Steel (DH-513 – DH-670)

**Connections** Brass (DH-051 – DH-447)  
Steel (Models DH-513 – DH-670)

## Internal Pressure Bypass Options

**Available in either 30 PSI or 60 PSI settings.**

This is a partial flow pressure bypass only. It is not designed to be a full flow system bypass.

**DH-051 through DH-447**  
Not serviceable

**DH-513**  
3/4" external, all steel valve  
Removable for service

**DH-524 through DH-670**  
1½" external, all steel valve  
Removable for service

## Recommended Port Orientation

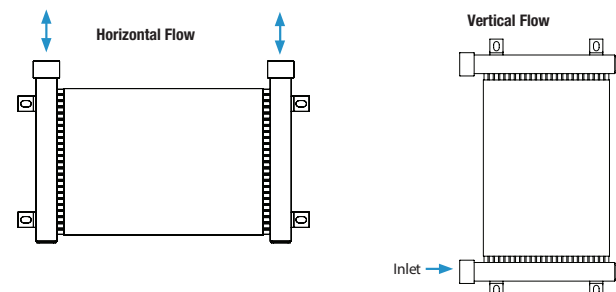

**Note: Mounting Kits for DH-051 thru DH-447 must be ordered separately, by part number and specified quantity. See Page 3 for Kit Info.**

\*To register for XSelector® please go to [www.thermaltransfer.com/get-in-touch/](http://www.thermaltransfer.com/get-in-touch/) and complete the XSelector® Inquiry form and submit.

Download the XSelector® for both Apple and Android formats by searching for XSelector® in their App Stores. You must first register for XSelector® before using it on mobile devices.

# Performance Curves

For additional sizing information consider using TTP's **XSelector**® online sizing Program.\*

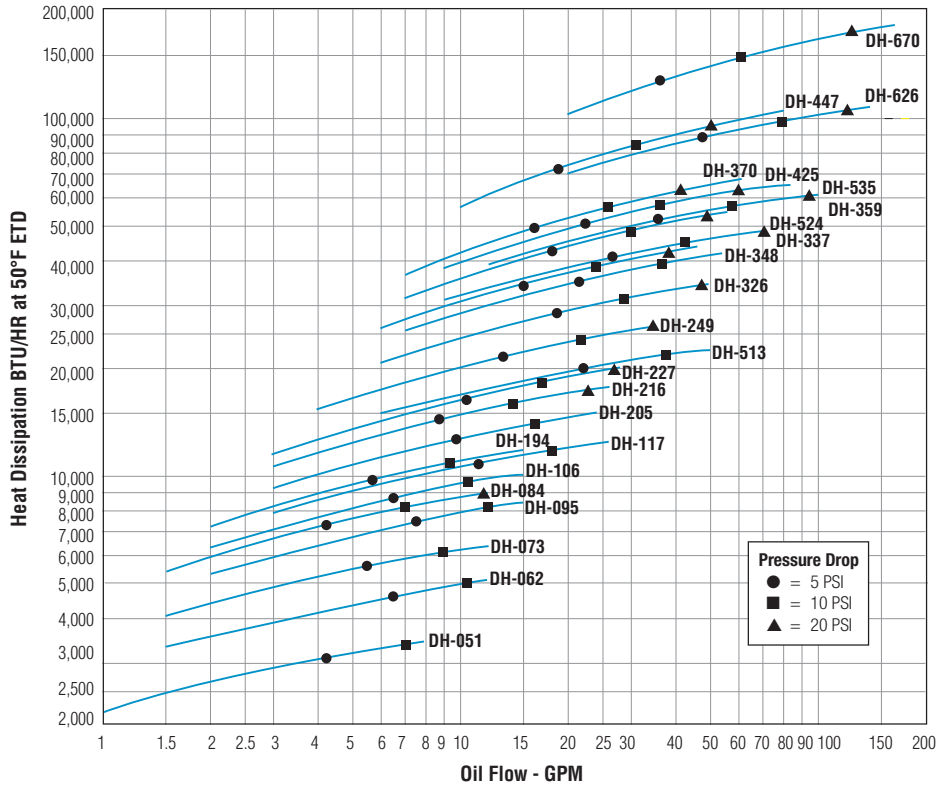

## Oil Pressure Correction

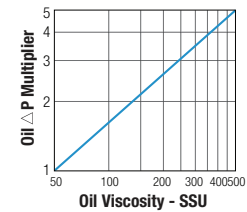

## Air Velocity Correction

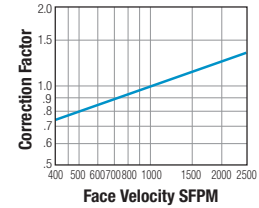

## Air Static Pressure Drop

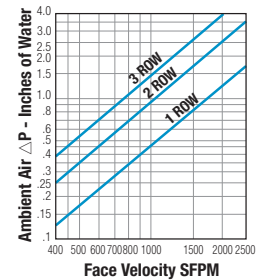

## Selection Procedure

Performance Curves are based on 50 SSU oil, 1000 Standard Feet per Minute (SFPM) Air Velocity, and a 50°F Entering Temperature Difference (ETD) ETD = Entering oil temperature - Ambient air temperature

**STEP 1 Determine Heat Load:** Heat load may be expressed as either Horsepower or BTU/HR  
 $\text{BTU/HR} = \text{Horsepower} \times 2545$

**STEP 2 Determine entering temperature difference:** The entering oil temperature is generally the maximum desired system temperature.  
 ETD = Entering oil temperature - Ambient air temperature.

**STEP 3 Determine the corrected heat dissipation to use the curves:**

$$\text{Corrected Heat Dissipation} = \frac{\text{BTU/HR}}{(\text{Heat Load})} \times \left[ \frac{50^\circ\text{F} \times C_v}{\text{Desired E.T.D} \times \text{Air Velocity Correction Factor}} \right]$$

## C<sub>v</sub> Viscosity Correction

Average Oil Temp °F	OIL				
	SAE 5 110 SSU at 100°F 40 SSU at 210°F	SAE 10 150 SSU at 100°F 43 SSU at 210°F	SAE 20 275 SSU at 100°F 50 SSU at 210°F	SAE 30 500 SSU at 100°F 65 SSU at 210°F	SAE 40 750 SSU at 100°F 75 SSU at 210°F
100	1.14	1.22	1.35	1.58	1.77
150	1.01	1.05	1.11	1.21	1.31
200	.99	1.00	1.01	1.08	1.10
250	.95	.98	.99	1.00	1.00

**STEP 4 Enter the Performance Curves** at the bottom with the GPM oil flow and proceed upward to the adjusted heat load from Step 3. Any curve on or above this point will meet these conditions.

**STEP 5 Calculate actual SFPM Air Velocity or SCFM** (Standard Cubic Feet Per Minute) using the Face Area from the table.

A.  $\text{SFPM Air Velocity}^* = \frac{\text{SCFM Air Flow}}{\text{Square Feet Face Area}}$

B.  $\text{SCFM Air Flow} = \text{SFPM Air Velocity} \times \text{Square Feet Face Area}$

\*If the Air Velocity calculated is different than the value in Step 3, recheck Corrected oil Pressure Drop.

**STEP 6 Multiply Oil Pressure Drop** from curve by correction factor found in Oil Δ P Correction Curve.

\*Note: If air velocity is unknown assume 750 SFPM.

\* To register for **XSelector**® please go to [www.thermaltransfer.com/get-in-touch/](http://www.thermaltransfer.com/get-in-touch/) and complete the **XSelector**® Inquiry form and submit.

Download the **XSelector**® for both Apple and Android formats by searching for **XSelector**® in their App Stores. You must first register for **XSelector**® before using it on mobile devices.

## Desired Reservoir Temperature

**Return Line Cooling:** Desired temperature is the oil temperature leaving the cooler. This will be the same temperature that will be found in the reservoir.

**Off-Line Recirculation Cooling Loop:** Desired temperature is the oil temperature entering the cooler. In this case, the oil temperature change must be determined so that the actual oil leaving temperature can be found.

Calculate the oil temperature change (oil  $\Delta T$ ) with this formula:

$$\text{Oil } \Delta T = (\text{BTU's/HR}) / (\text{GPM Oil Flow} \times 210).$$

To calculate the oil leaving temperature from the cooler, use this formula:

$$\text{Oil Leaving Temp.} = \text{Oil Entering Temp} - \text{Oil } \Delta T.$$

This formula may also be used in any application where the only temperature available is the entering oil temperature.

**Oil Pressure Drop:** Most systems can tolerate a pressure drop through the heat

exchanger of 20 to 30 PSI. Excessive pressure drop should be avoided. Care should be taken to limit pressure drop to 5 PSI or less for case drain applications where high back pressure may damage the pump shaft seals.

## Oil Temperature

Typical operating temperature ranges are:

Hydraulic Motor Oil	110°- 130°F
Hydrostatic Drive Oil	130°- 180°F
Bearing Lube Oil	120°- 160°F
Lube Oil Circuits	110°- 130°F

Oil Temp °F	Typical Oil Viscosity, SSU				
	SAE 5	SAE 10	SAE 20	SAE 30	SAE 40
100	110	150	275	500	750
150	60	70	100	135	190
210	40	43	50	65	75

## Dimensions

**For 3D models and spec sheets visit the DH product page on our website.**  
<https://www.thermaltransfer.com/product/dh-series>

### DH-051 thru DH-447

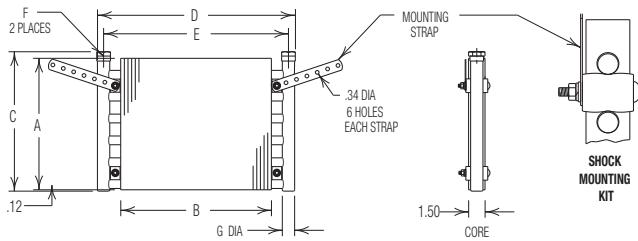

#### Mounting Kits

Optional Mounting Kits are available with or without straps.

	Part Number
With strap	L-84741
Without strap	L-84740

Model	A	B	C	D	E	F		G Diameter	Quantity Mounting Kits	Face Area (SQ FT)	Weight (LBS)
						NPT	SAE				
DH-051	4.00	11.25	4.50	15.57	14.44	1/2	-10 7/8-14	0.88	2	0.31	2
DH-062	6.00	11.25	6.50	15.25	14.12	1/2	-10 7/8-14	0.88	4	0.47	3
DH-073	6.00	14.25	6.50	18.25	17.12	1/2	-10 7/8-14	0.88	4	0.60	3
DH-084	6.00	20.25	6.50	24.25	23.12	1/2	-10 7/8-14	0.88	4	0.84	4
DH-095	8.00	14.25	8.50	18.25	17.12	1/2	-10 7/8-14	0.88	4	0.79	4
DH-106	8.00	17.25	8.50	21.12	20.12	1/2	-10 7/8-14	0.88	4	0.96	5
DH-117	8.00	20.25	8.50	24.25	23.12	1/2	-10 7/8-14	0.88	4	1.12	5
DH-194	12.00	13.75	12.73	18.26	16.88	3/4	-12 1 1/16-12	1.12	4	1.15	6
DH-205	12.00	16.75	12.73	21.26	19.88	3/4	-12 1 1/16-12	1.12	4	1.40	7
DH-216	12.00	19.75	12.73	24.26	22.88	3/4	-12 1 1/16-12	1.12	4	1.64	8
DH-227	14.00	19.75	14.73	24.26	22.88	3/4	-12 1 1/16-12	1.12	4	1.92	9
DH-249	18.00	19.75	18.73	24.26	22.88	3/4	-12 1 1/16-12	1.12	6	2.47	12
DH-326	24.00	19.25	25.00	24.37	22.62	1	-16 1 5/16-12	1.38	8	3.21	16
DH-337	24.00	25.25	25.00	30.37	28.62	1	-16 1 5/16-12	1.38	8	4.21	20
DH-348	30.00	19.25	31.00	24.37	22.62	1	-16 1 5/16-12	1.38	8	4.00	19
DH-359	30.00	25.25	31.00	30.37	28.62	1	-16 1 5/16-12	1.38	8	5.26	24
DH-370	30.00	31.25	31.00	36.37	34.62	1	-16 1 5/16-12	1.38	8	6.51	28
DH-425	36.00	24.75	37.32	30.38	28.38	1 1/4	-20 1 5/8-12	1.62	8	6.19	32
DH-447	40.00	36.75	41.41	42.38	40.38	1 1/4	-20 1 5/8-12	1.62	8	10.21	43

All dimensions in inches. Weights are for aluminum fins. After making your base model selection with the connection of your choice, please refer to the How to Order section.

Note: We reserve the right to make reasonable design changes without notice.

# Dimensions

For 3D models and spec sheets visit the DH product page on our website.  
<https://www.thermaltransfer.com/product/dh-series>

## DH-513 thru DH-670

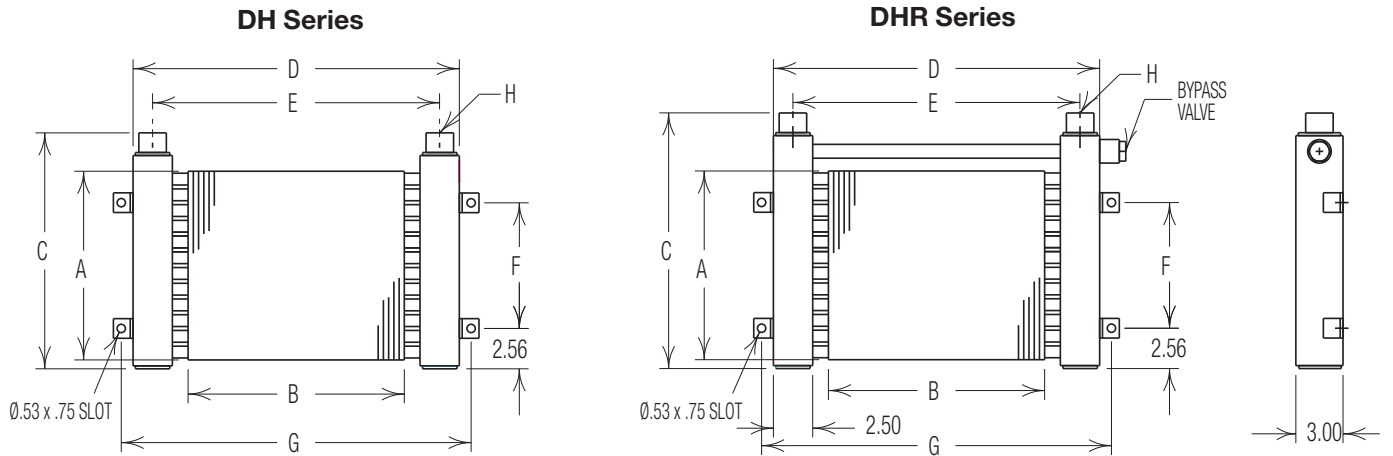

Model	A	B	C		D		E	F	G	H		Face Area (SQ FT)	Weight (LBS)
			DH	DHR	DH	DHR				NPT	SAE		
DH-513	12.00	13.75	15.00	16.25	20.75	22.41	18.25	8.00	22.17	3/4	-12 1 1/16-12	1.15	16
DH-524	18.00	19.75	21.00	23.25	26.75	28.13	24.25	14.00	28.17	3/4	-12 1 1/16-12	2.47	27
DH-535	24.00	19.25	27.00	29.25	26.25	27.63	23.75	20.00	27.67	1	-16 1 5/16-12	3.21	53
DH-626	36.00	22.75	39.03	41.28	30.13	31.32	27.25	32.00	31.17	2	-32 1/2-12	5.69	60
DH-670	40.00	34.75	43.03	45.28	42.13	43.32	39.25	36.00	43.17	2	-32 1/2-12	9.65	115

All dimensions in inches. Weights are for aluminum fins.  
 After making your base model selection with the connection of your choice, please refer to the How to Order section.